

Educational Packet

“Japanese Four Seasons”

Performed by Yasu Ishida

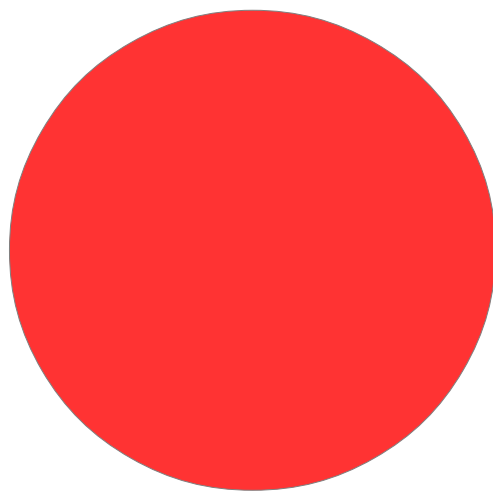
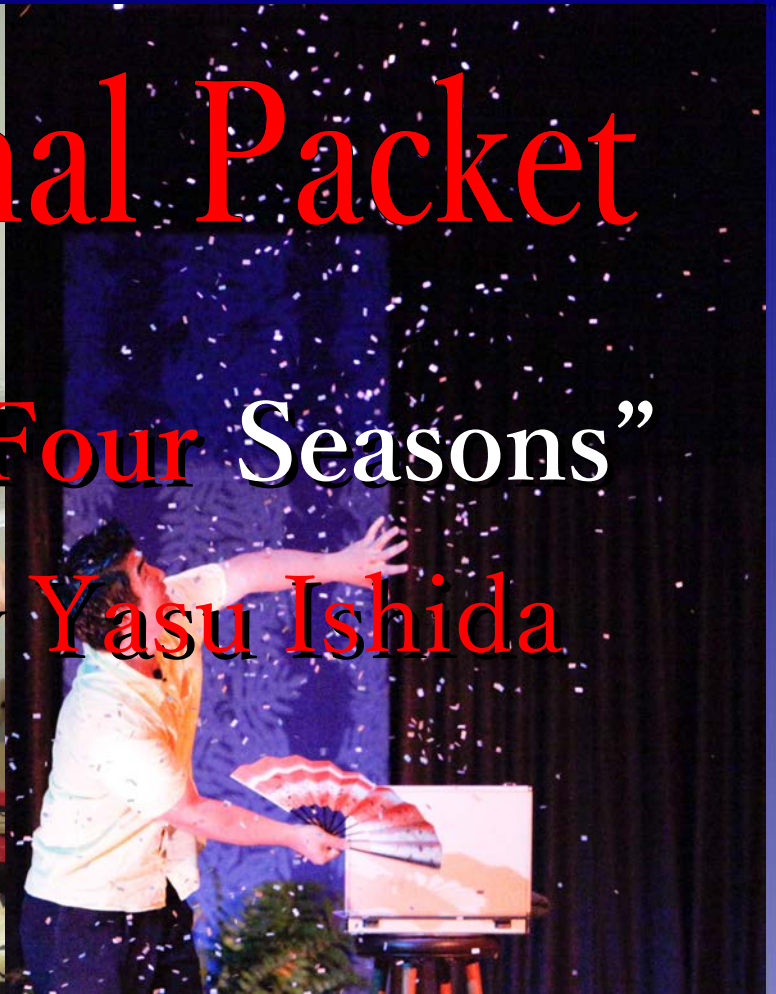

www.yasutheatre.com

“Japanese Four Seasons” explores various Japanese traditional performances, music, stories, Japanese lion dance, and origami with magic tricks. It is not only an entertaining but also an educational show with lots of audiences interactions.

Video Link: <https://www.youtube.com/watch?v=KrGI6yUiLGc>

Introducing Yasu

Curriculum Connection

- English & Japanese Language (Viewing and Speaking), Math (Geometry and Spatial Senses), Geography, Visual Arts & Theater (Cultural and Historical Connection), Music

Yasu Ishida was born in Ube, Japan. Inspired by the movie "Patch Adams", he came to the U.S. to become a professional hospital clown. He earned a Bachelor's degree in Theatre Arts, and also graduated from the Chavez Studio of Magic, the most prestigious magic school in the world.

Yasu was a resident magician at the Waikiki Aquarium where he performed magic shows and taught ocean themed magic tricks to kids weekly. During the summer of 2012, he performed with Zany Umbrella Circus on a New York & Pittsburgh Tour.

PERFORMING ARTS

SHOW ACTIVITY

MAKING ORIGAMI ANIMALS

- **LENGTH:** 2 Class hours

- **GRADE LEVEL:** K-12

- **SUBJECT AREA:** Language Arts (Reading, Writing), Math (Geometry and Spatial Sense), Foreign Language (Culture), Visual Arts (Skills and Techniques, Cultural and Historical Connections), Music (Cultural and Historical Connections), Science

OBJECTIVES: Students will;

1. Create paper origami animals using precise constructing skills and techniques.
2. Work imaginatively and symbolically.
3. Develop interest in and respect for cultures.
4. Be exposed to foreign music and animals and compare it with their own.
5. Compare two different cultures and raise awareness of diversity.

PROCEDURE: Show how to make an origami paper animals (Dog, Horse, Cat) using the instructions below. Then using Origami animals, teach how their animal bark differently in two different cultures. While students are making origami, play Japanese traditional music, Sakura.

Vocabulary

Sakura – The cherry blossom

Fue – Flute

Taiko – Japanese traditional drum

Origami – The traditional Japanese art form of “folding paper”

Tama-sudare – “Bamboo Blind” used in Japanese traditional street performance

Haru – “Spring”

Natsu – “Summer”

Aki – “Fall”

Fuyu – “Winter”

Origami Instruction: A DOG

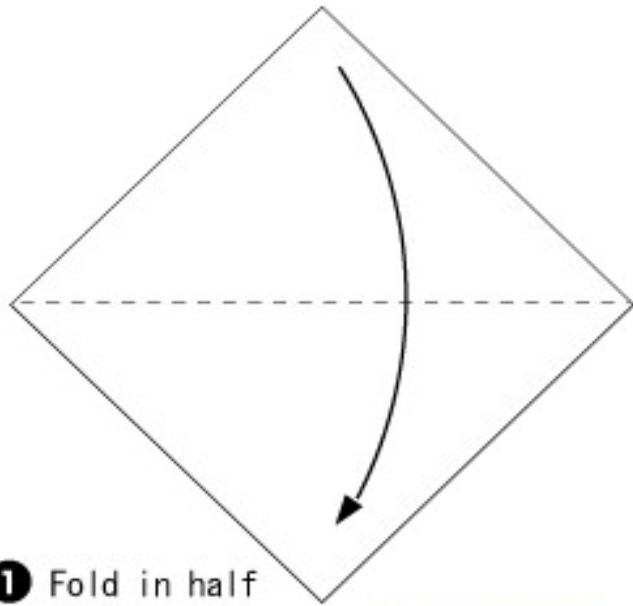

1 Fold in half

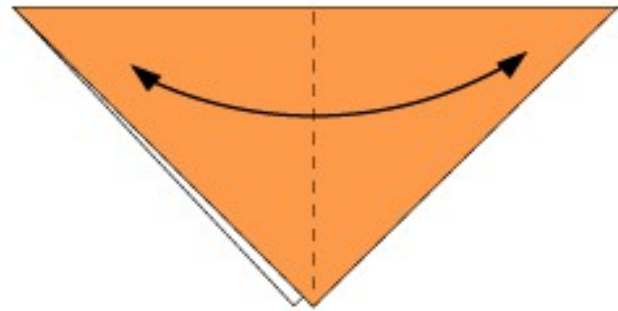

2 Fold in half to make crease

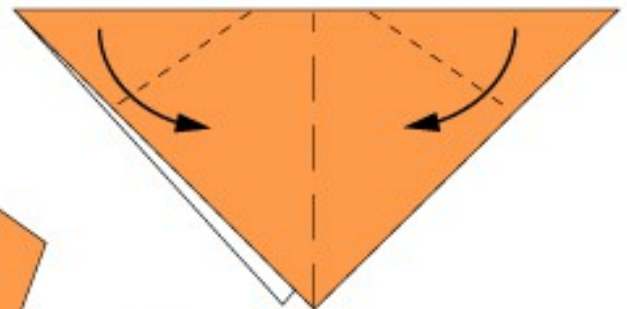

3 Fold in the dotted line

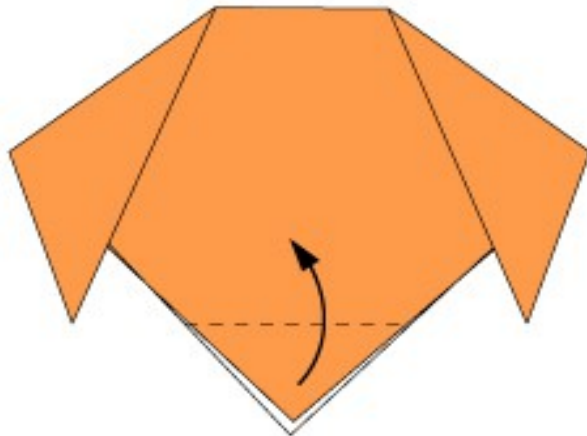

4 Fold in the dotted line

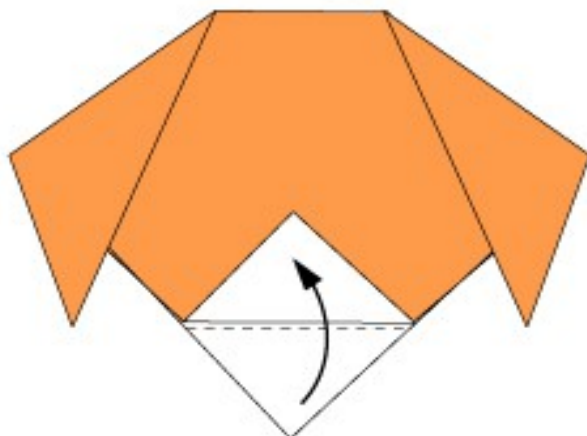

5 Fold in the dotted line

6 Draw a face and finished

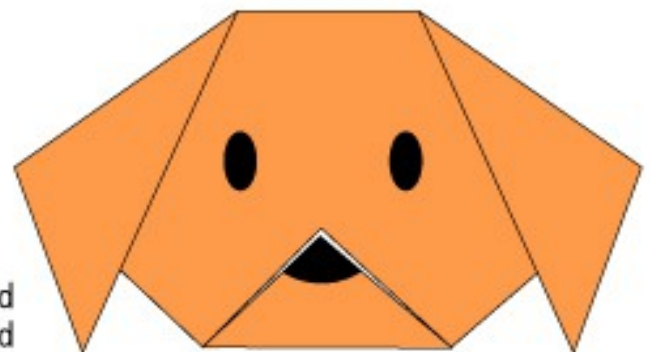

A Dog (face)

Origami Instruction: A CAT

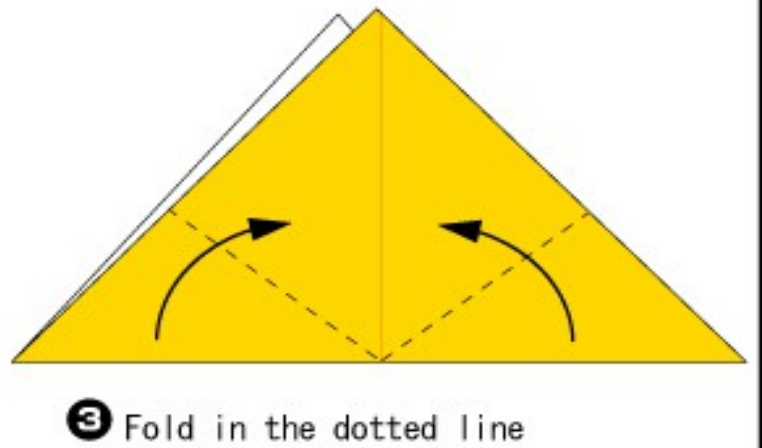
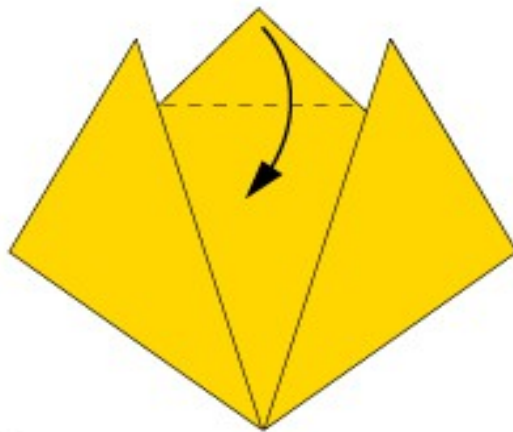
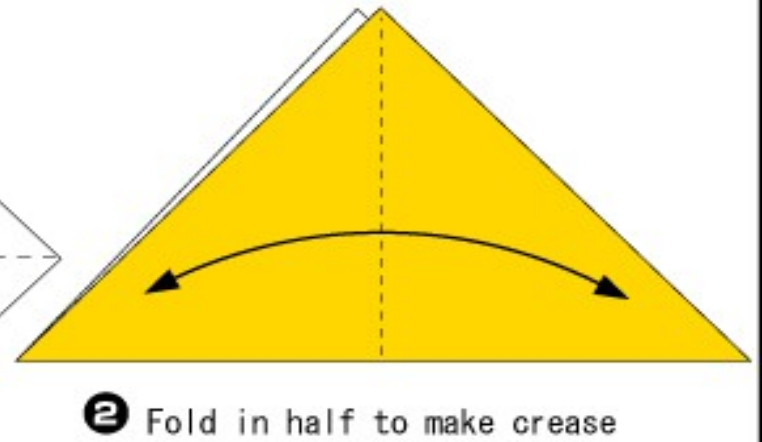
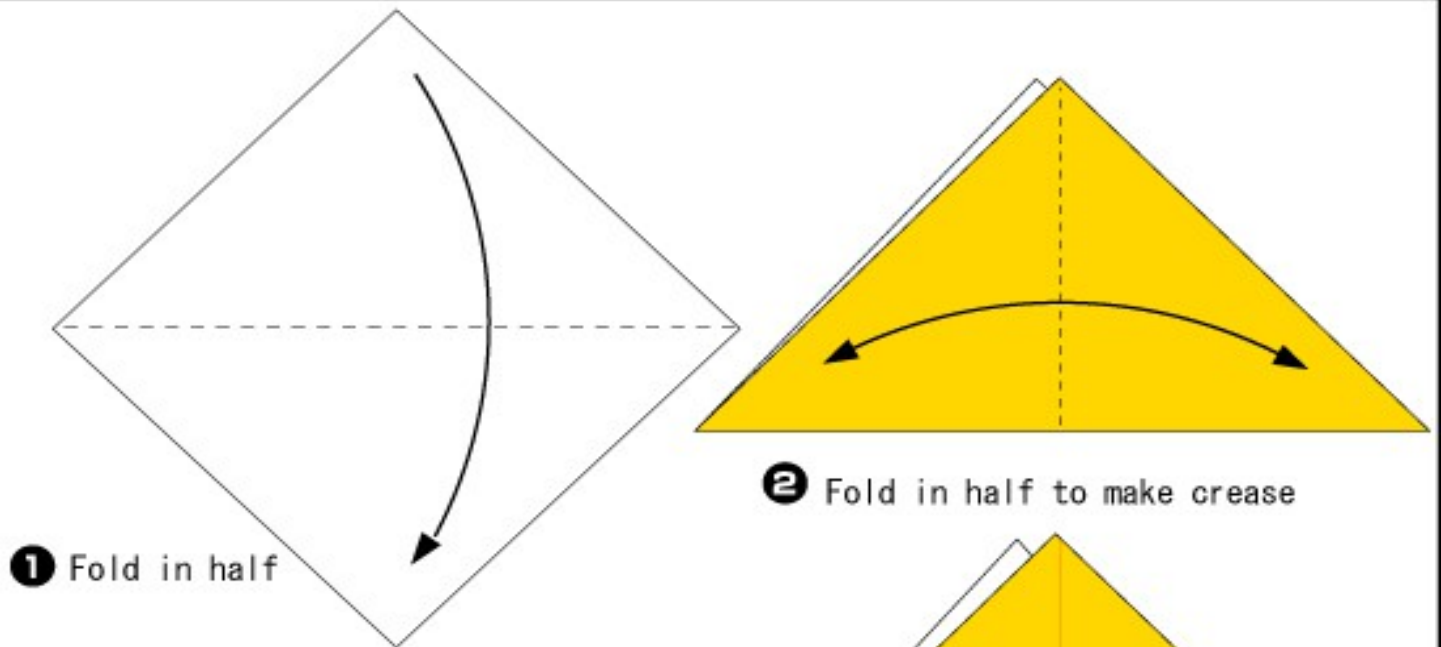

5 Turn over

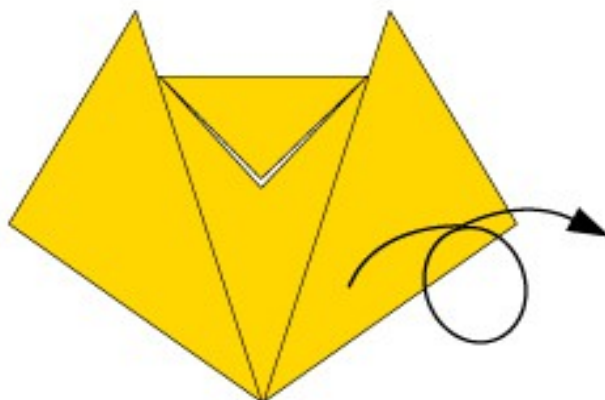

*Traditional
Diagram: Fumiaki Shingu

A Cat

Origami Instruction: A HORSE

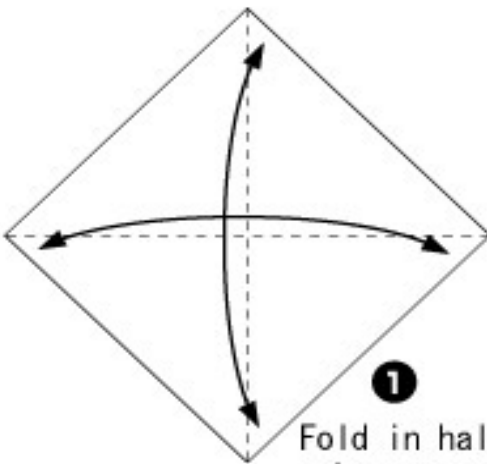

1
Fold in half twice to
make creases and fold back

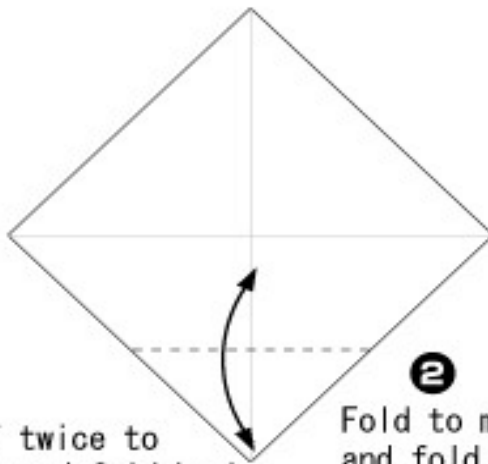

2
Fold to make a crease
and fold back

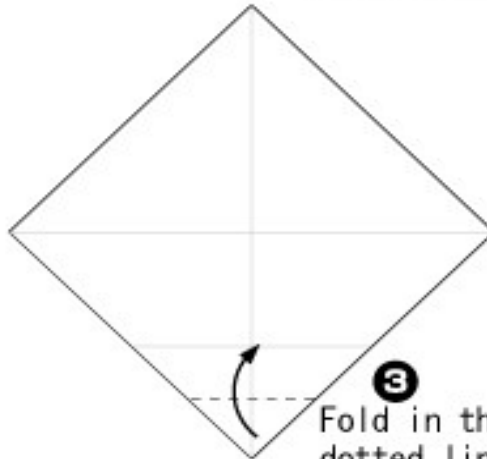

3
Fold in the
dotted line

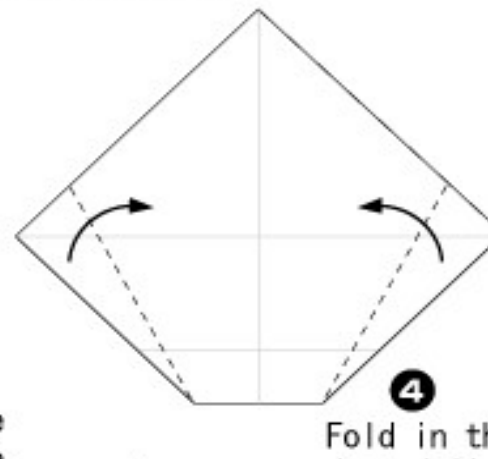

4
Fold in the
dotted line

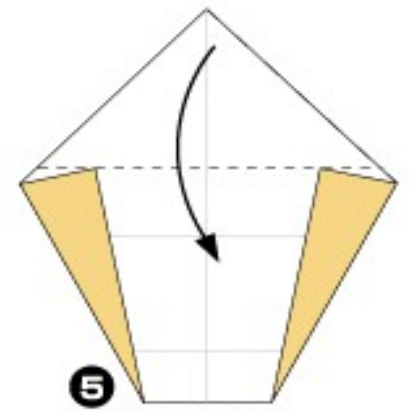

5
Fold in the
dotted line

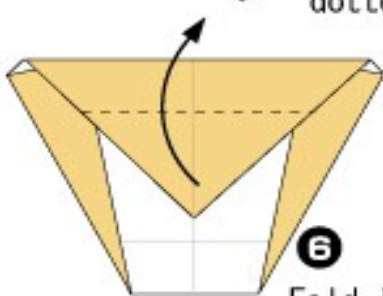

6
Fold in the
dotted line

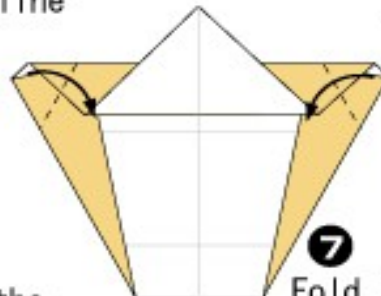

7
Fold in the
dotted line

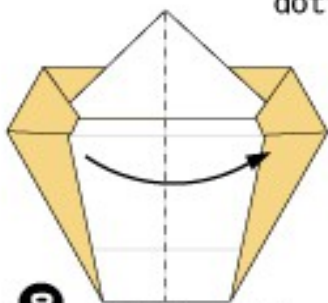

8
Fold in half

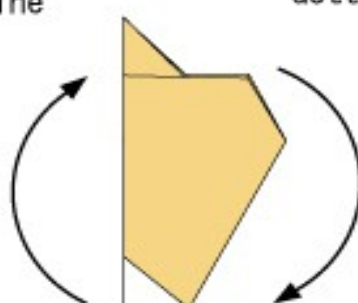

9
Turn around

Draw a face
and finished

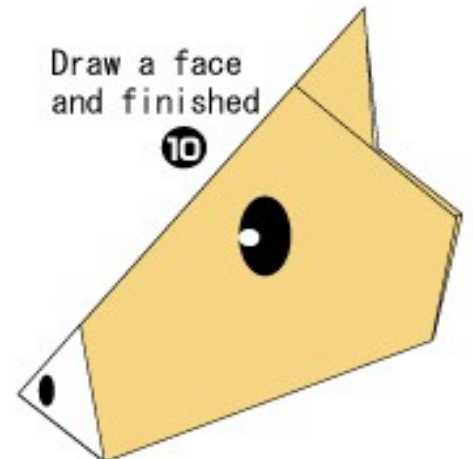

10

A Horse(face)

Different Animal Sounds In the U.S. And Japan

	In America	In Japan
DOG	Bow Bow Woof Woof	Wan Wan
CAT	Meow	Nyaa Nyaa
HORSE	Neigh	Hihiiin
ROOSTER	Cock-a- doodle-doo	Kokekokko
SHEEP	Baa Baa	Mee Mee

Post-Show Activity

Responding to the SHOW

1. What kind of flower petal was in spring section?

- Sakura (Cherry Blossom)

2. What does “Sore-sore-sore-sore!” mean in summer section?

- “Let's go! Let's go! Let's go! Let's go!”

3. How many bamboo sticks are in the bamboo blind at summer section?

- 56 sticks

4. What kind of shape did you see in Origami story?

- A Stalk of Bamboo, A Baby Girl, A Golden Sake Cup, A Samurai Hat, A Hakama: Japanese traditional pants, A Royal Golden Chair, A Boat, A Butterfly, A Moon

5. In lion dance, how many instruments did you hear?

- Three (A Japanese Bamoboo Flute, A Taiko Drum, A Bell)

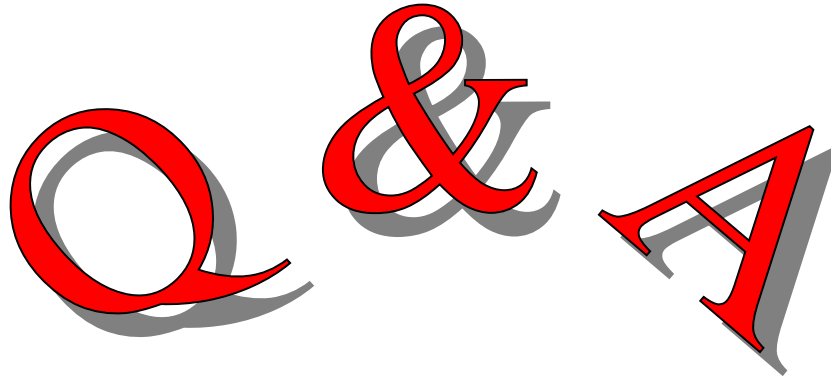

- 1. Where is in Japan? And how far is Japan from the U.S.?**
 - Let's look a map. Japan is in Asia. It has four islands surrounded by Pacific Ocean and Sea of Japan. It is 3,850 miles away from Hawaii. It takes six hours' flight from Hawaii to Japan.
- 2. How large is Japan?**
 - Compared to the U.S., Japan is smaller. It is about a size of California.
- 3. How many people live there?**
 - About 130,000,000 people live in Japan. That is less than half of the population of the U.S.
- 4. How many states do they have in Japan?**
 - In Japan, there are 47 states but it is called prefectures.
- 5. What does the red spot in the middle of the Japanese Flag means?**
 - It is the symbol of the sun and the flag is known as the rising sun.
- 6. What are Japanese foods?**
 - Rice and noodles are very popular as well as fish. Japanese people love Sushi, Udon and Soba Noodles.
- 7. How to say hello, good-bye, magic in Japanese?**
 - Konnichiwa, Sayonara, Mahou

Resources Resources

Internet

Kids Web to Japan

<http://web-japan.org/kidsweb/>

Origami Club

<http://en.origami-club.com/>

Resource & Lesson Plan for Teachers

<http://www.tjf.or.jp/takarabako/index.htm>

Books

The Moon Princess/ Kaguyahime

(English and Japanese Edition)

- By Ralph F. McCarthy

All About Japan: Stories, Songs, Crafts and More

- By Willamarie Moore & Kazumi Wilds

Origami in Action : Paper Toys That Fly, Flap, Gobble, and Inflate

- By Robert J. Lang